

Industrial 7 Sheeting

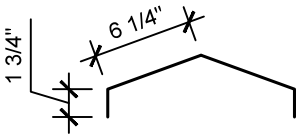

16" Ridge

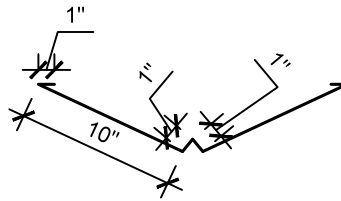

24" Valley

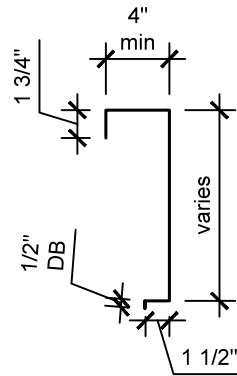

24" Gable

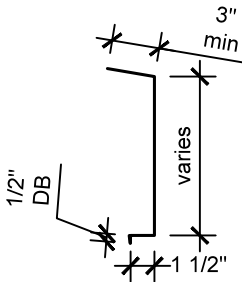

18" Fascia

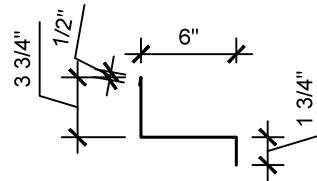

12" Side Wall

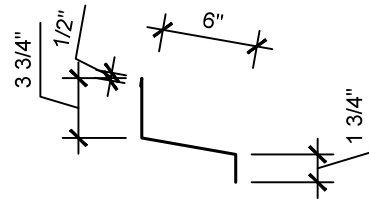

12" Head Wall

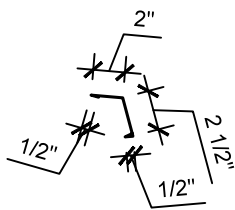

6" Drip Edge

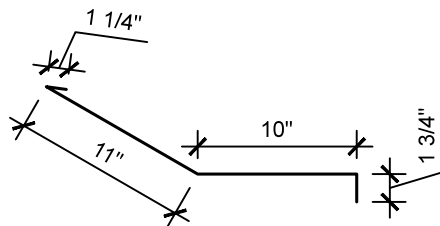

24" Transition

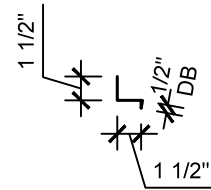

4" Wall Angle



MORE than just roofing

TEL: 1(868) 285-9164 www.roofsystemstt.com

Drawn: XXX

Profile: Industrial 7

Scale: NTS

Detail: Flashing Details

Dwg. Chk. XXX

Dwg. No.

Date: 01/01/2019

009

Job. No.	Sheet No.	Rev.
----------	-----------	------

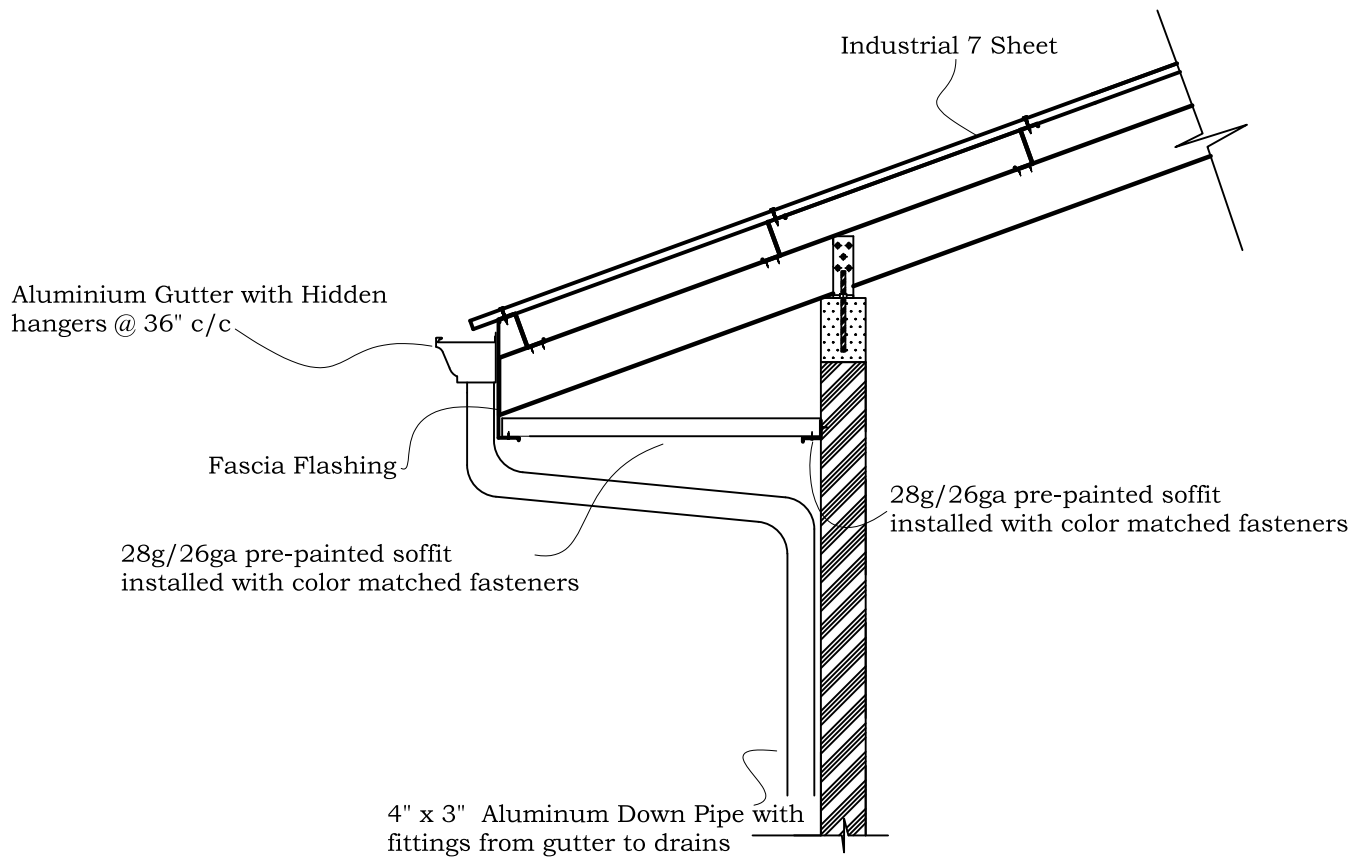

FASCIA - TYPICAL







MORE than just roofing

TEL: 1(868) 285-9164 www.roofsystemstt.com

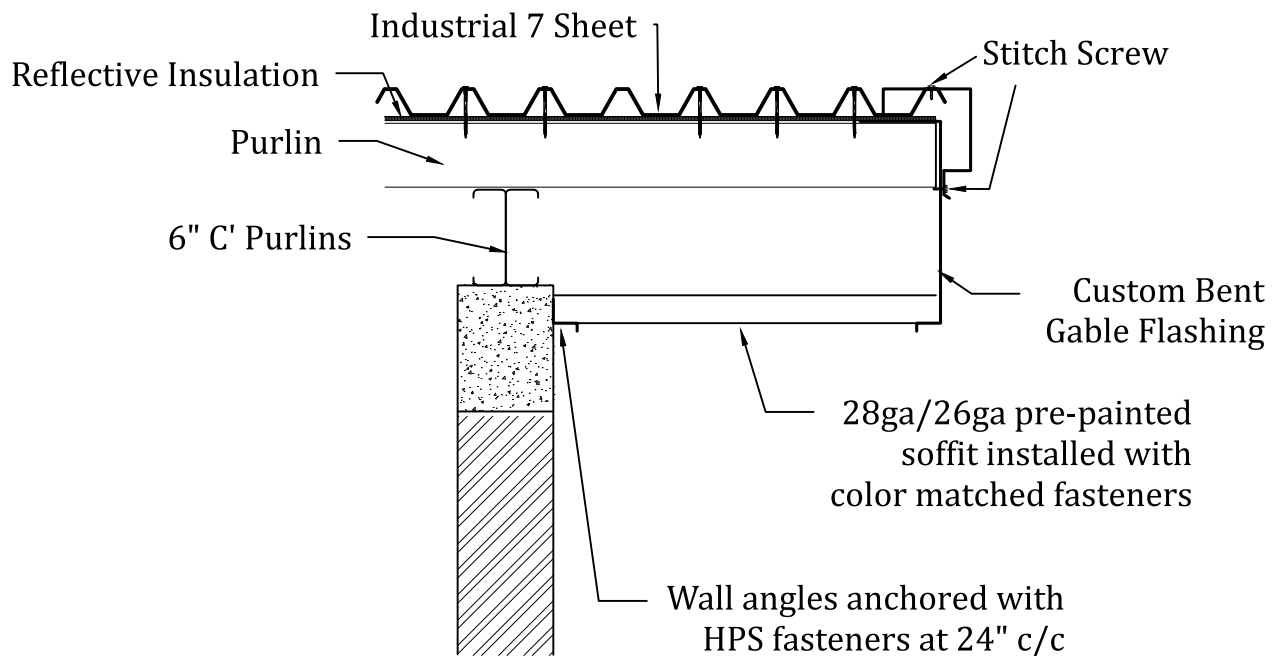
Drawn: XXX	Profile: Industrial 7
Scale: NTS	Detail: Fascia Detail
Dwg. Chk. XXX	Dwg. No.
Date: 01/01/2019	001
	Job. No. Sheet No. Rev.



GABLE - TYPICAL







MORE than just roofing

TEL: 1(868) 285-9164 www.roofsystemstt.com

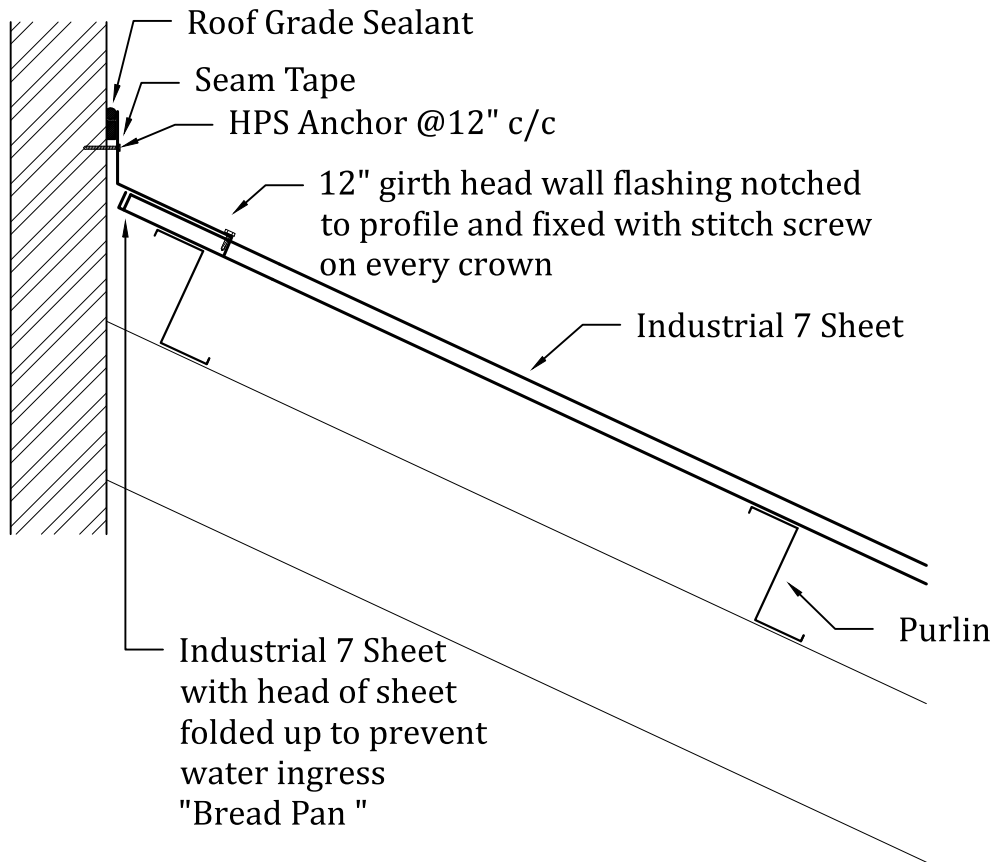
Drawn: XXX	Profile: Industrial 7
Scale: NTS	Detail: Gable Detail
Dwg. Chk. XXX	Dwg. No.
Date: 01/01/2019	002
	Job. No. Sheet No. Rev.



HEAD WALL - TYPICAL







MORE than just roofing

TEL: 1(868) 285-9164 www.roofsystemstt.com

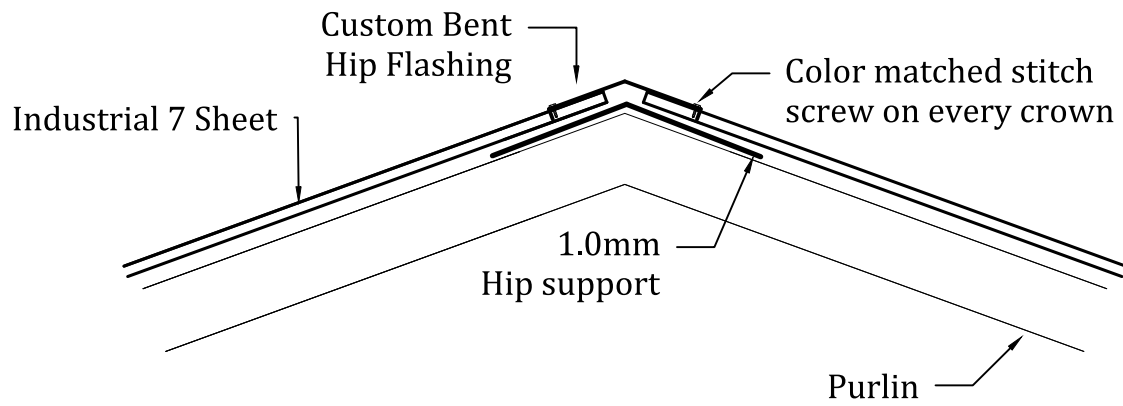
Drawn: XXX	Profile: Industrial 7
Scale: NTS	Detail: Head Wall Detail
Dwg. Chk. XXX	Dwg. No.
Date: 01/01/2019	006
	Job. No. Sheet No. Rev.



Hip- TYPICAL

ROOF SYSTEMS

RELCO

LIFT
CARIBBEAN

GGI
WINDOWS & DOORS

MORE than just roofing

TEL: 1(868) 285-9164 www.roofsystemstt.com

Drawn: XXX	Profile: Industrial 7		
Scale: NTS	Detail: Hip Detail		
Dwg. Chk. XXX	Dwg. No.		
Date: 01/01/2019	005		
	Job. No.	Sheet No.	Rev.

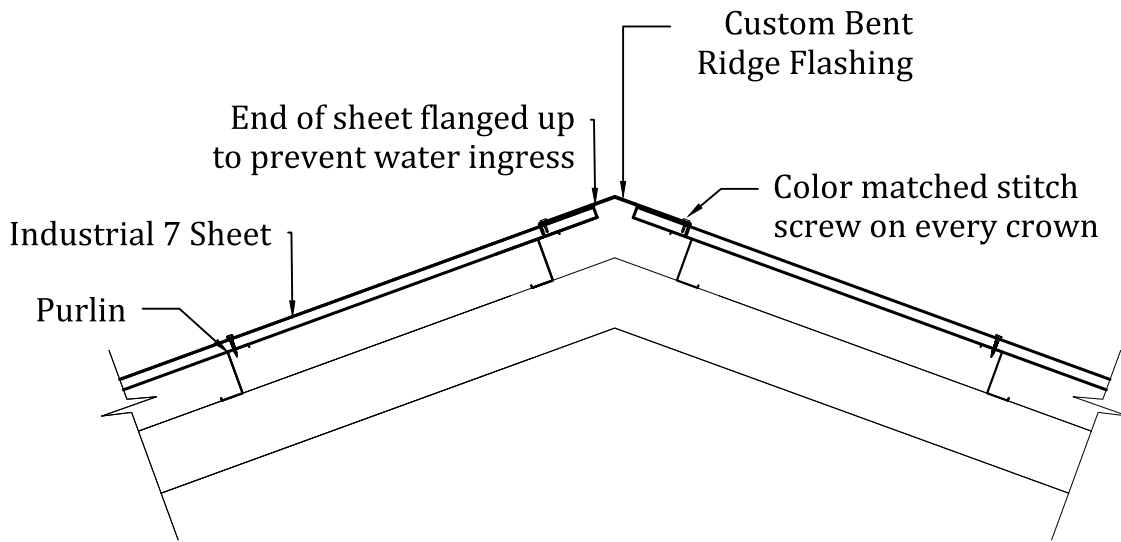

RIDGE - TYPICAL







MORE than just roofing

TEL: 1(868) 285-9164 www.roofsystemstt.com

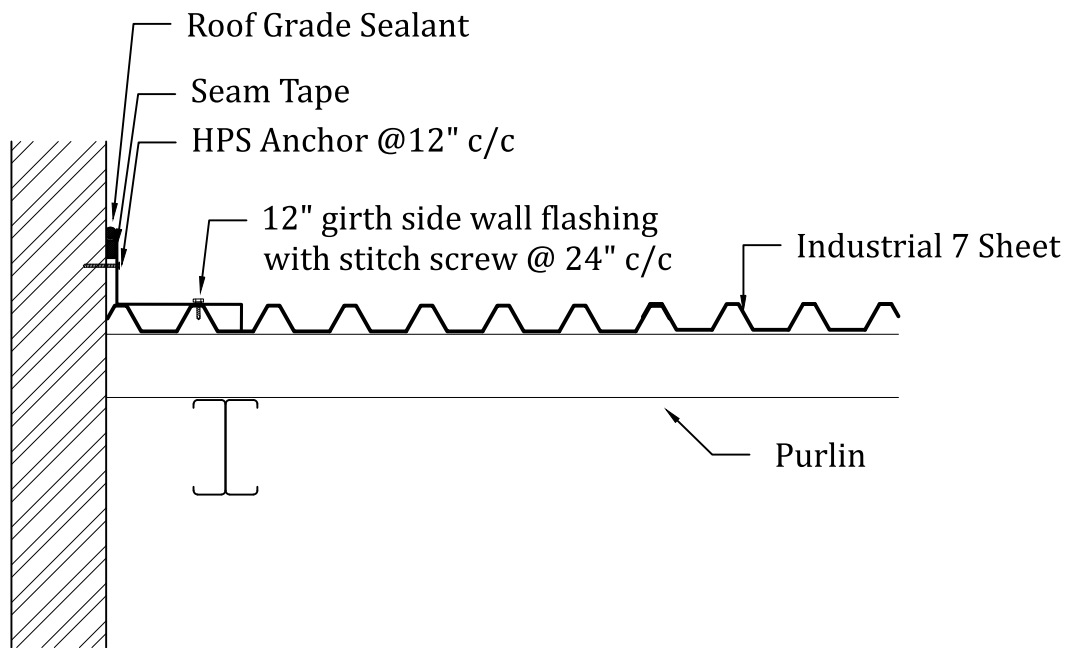
Drawn: XXX	Profile: Industrial 7
Scale: NTS	Detail: Ridge Detail
Dwg. Chk. XXX	Dwg. No.
Date: 01/01/2019	004
	Job. No. Sheet No. Rev.



SIDE WALL - TYPICAL







ROOF SYSTEMS™ **RELLCO** **LIFT** **GGI**
CARIBBEAN WINDOWS & DOORS

MORE than just roofing

TEL: 1(868) 285-9164 www.roofsystemstt.com

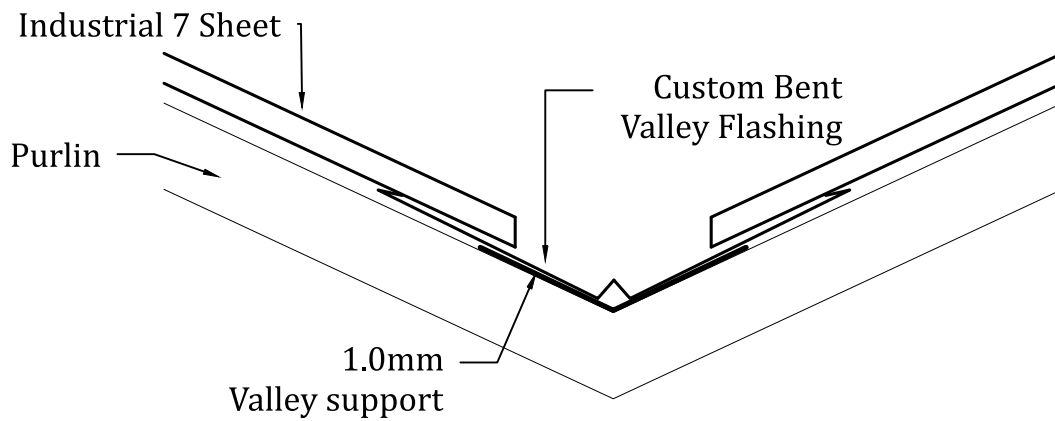
Drawn: XXX	Profile: Industrial 7		
Scale: NTS	Detail: Side Wall Detail		
Dwg. Chk. XXX	Dwg. No.		
Date: 01/01/2019	007		
	Job. No.	Sheet No.	Rev.



VALLEY - TYPICAL





MORE than just roofing

TEL: 1(868) 285-9164 www.roofsystemstt.com

Drawn: XXX	Profile: Industrial 7
Scale: NTS	Detail: Valley Detail
Dwg. Chk. XXX	Dwg. No.
Date: 01/01/2019	003
	Job. No. Sheet No. Rev.