

Standing Seam

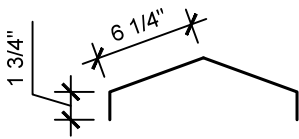

16" Ridge

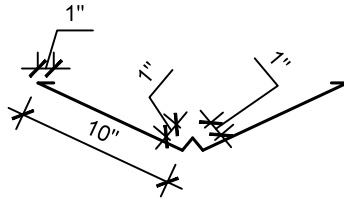

24" Valley

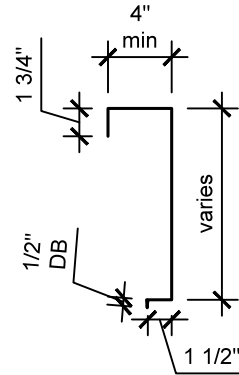

24" Gable

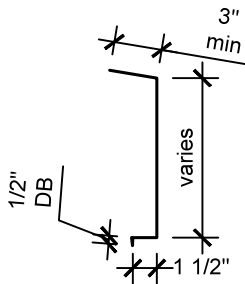

18" Fascia

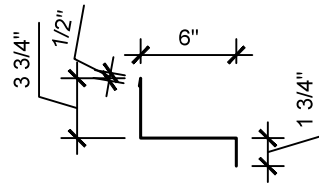

12" Side Wall

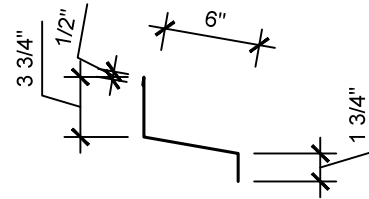

12" Head Wall

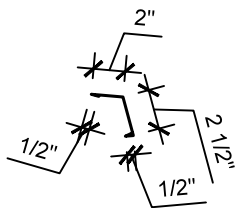

6" Drip Edge

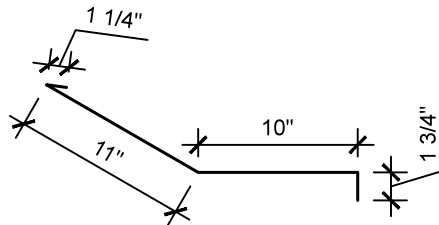

24" Transition

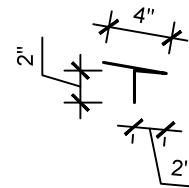

8" Starter

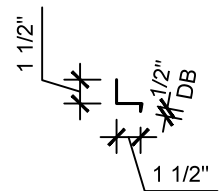

4" Wall Angle







**MORE** than just roofing

TEL: 1(868) 285-9164 [www.roofsystemstt.com](http://www.roofsystemstt.com)

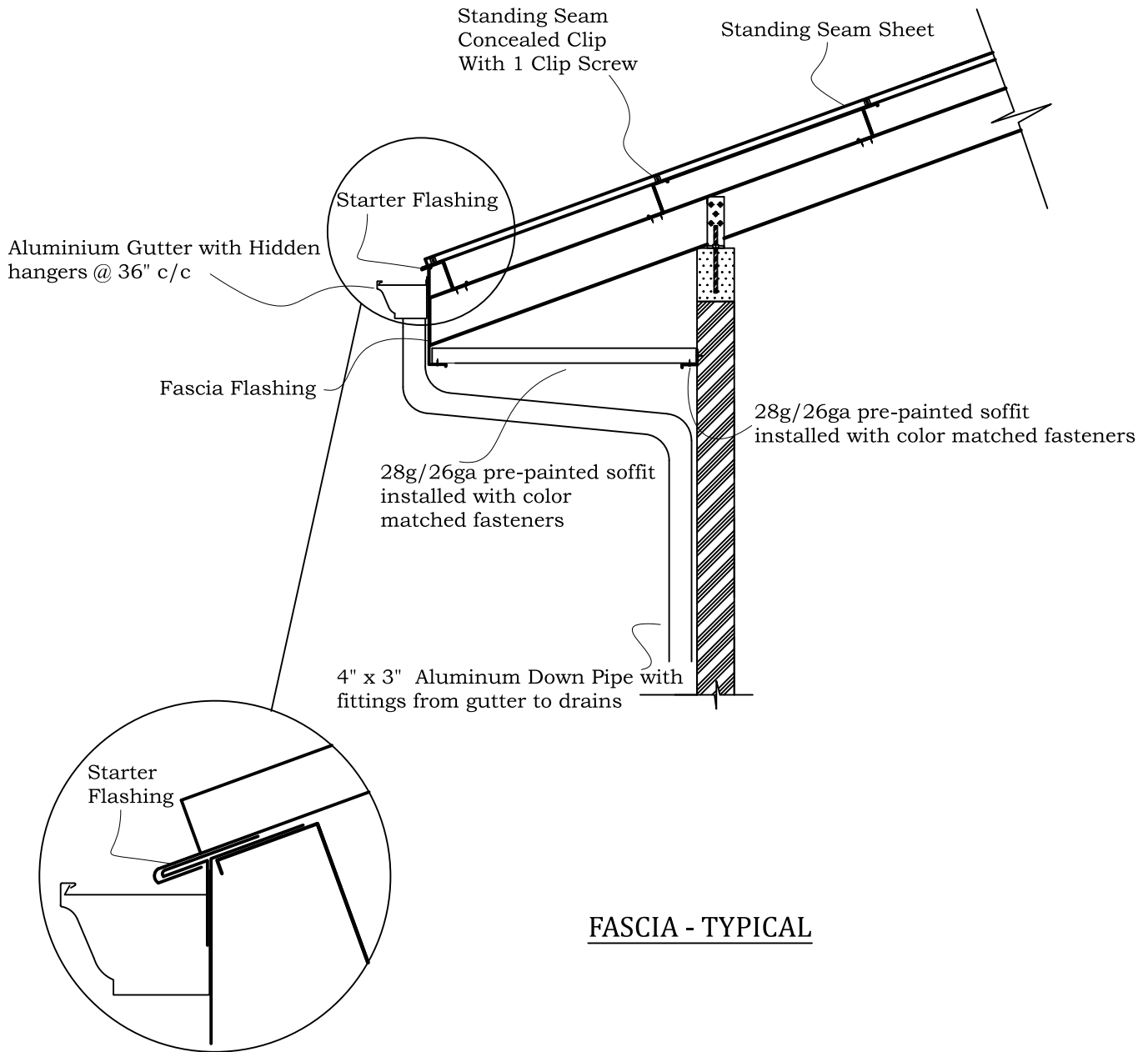
Drawn: XXX	Profile: Standing Seam		
Scale: NTS	Detail: Flashing Details		
Dwg. Chk. XXX	Dwg. No.		
Date: 01/01/2019	009		
	Job. No.	Sheet No.	Rev.



FASCIA - TYPICAL

**ROOF SYSTEMS**  
**RELCO**  
**LIFT IT**  
CARIBBEAN  
**GGI**  
WINDOWS & DOORS

**MORE than just roofing**

TEL: 1(868) 285-9164 [www.roofsystemstt.com](http://www.roofsystemstt.com)

Drawn: XXX	Profile: Standing Seam		
Scale: NTS	Detail: Fascia Detail		
Dwg. Chk. XXX	Dwg. No.		
Date: 01/01/2019	001		
	Job. No.	Sheet No.	Rev.

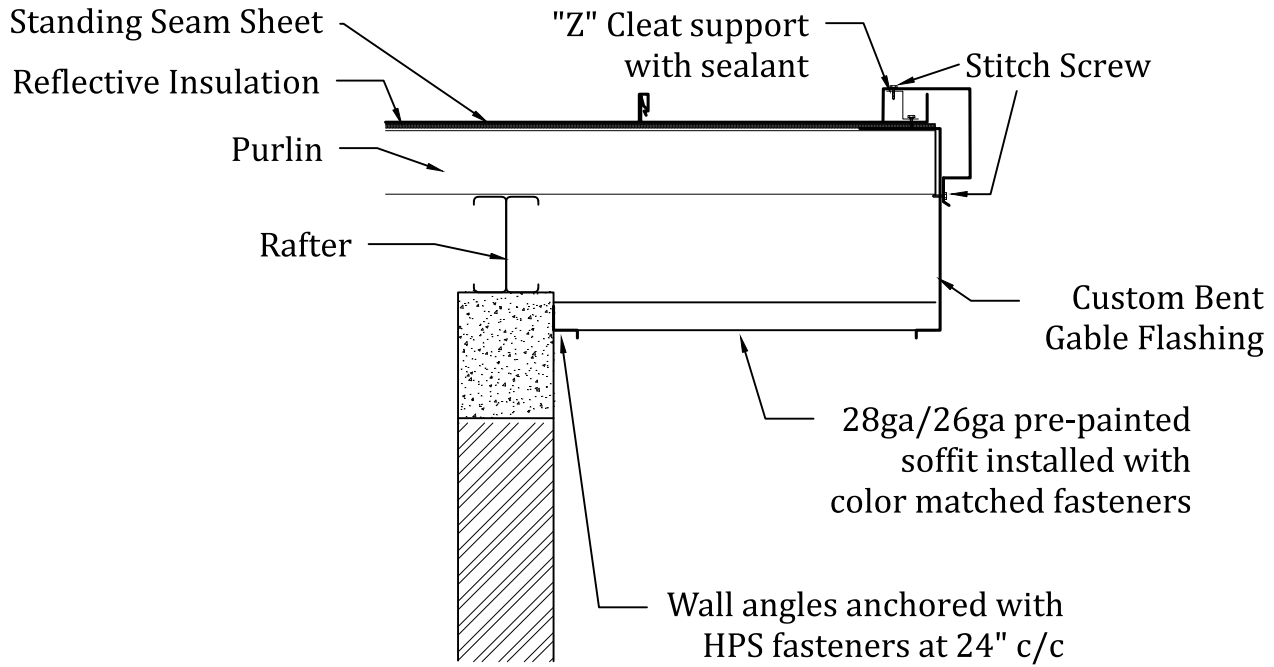

GABLE - TYPICAL

**ROOF SYSTEMS™**

**BELLCO**

**LIFT CARIBBEAN**

**GGI WINDOWS & DOORS**

**MORE than just roofing**

**TEL: 1(868) 285-9164 www.roofsystemstt.com**

Drawn: XXX	Profile: Standing Seam
Scale: NTS	Detail: Gable End Detail
Dwg. Chk. XXX	Dwg. No.
Date: 01/01/2019	002
	Job. No.   Sheet No.   Rev.

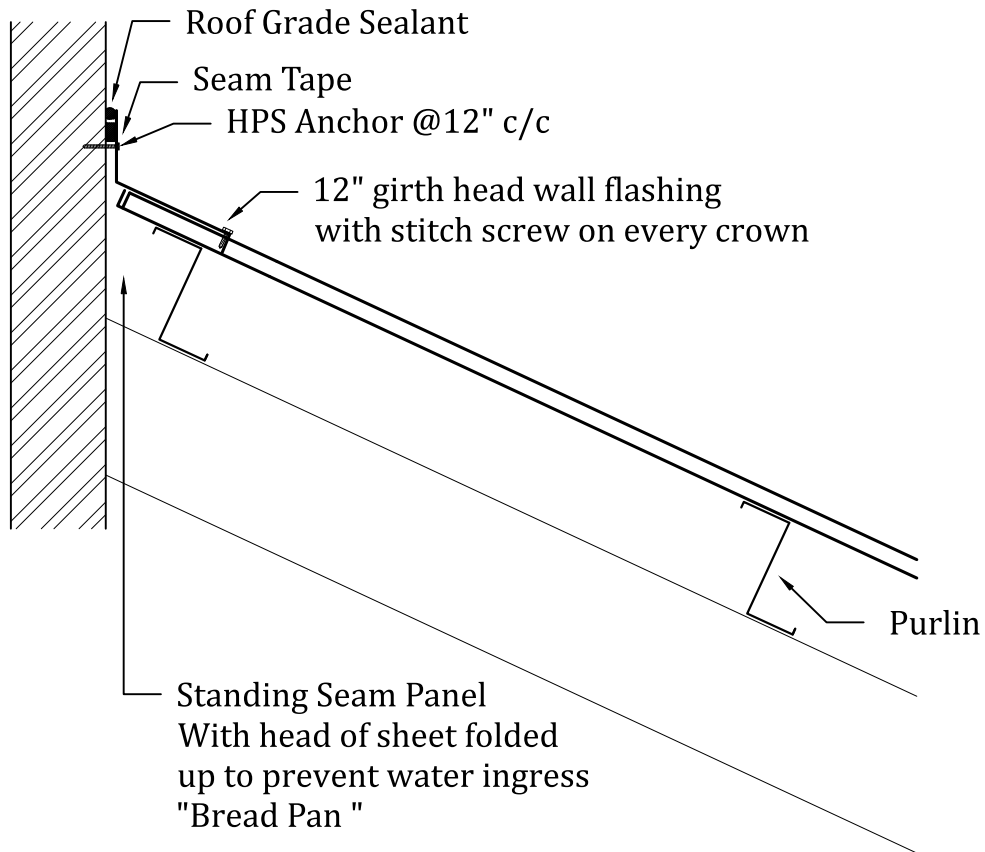

HEAD WALL - TYPICAL







**ROOF SYSTEMS™** MORE than just roofing

TEL: 1(868) 285-9164 [www.roofsystemstt.com](http://www.roofsystemstt.com)

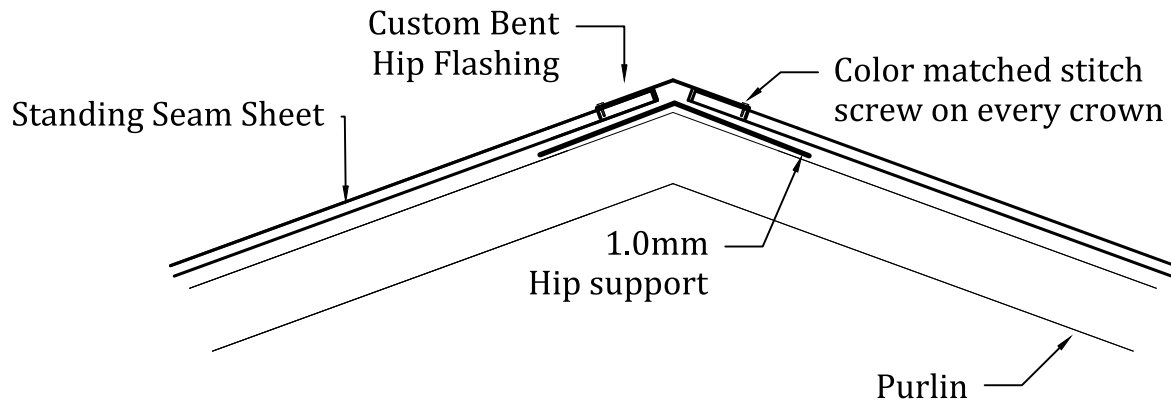
Drawn: XXX	Profile: Standing Seam
Scale: NTS	Detail: Head Wall Detail
Dwg. Chk. XXX	Dwg. No.
Date: 01/01/2019	006
	Job. No.   Sheet No.   Rev.



Hip- TYPICAL

**ROOF SYSTEMS**  
**RELCO**  
**LIFT CARIBBEAN**  
**GGI WINDOWS & DOORS**  
**MORE than just roofing**  
**TEL: 1(868) 285-9164 www.roofsystemstt.com**

Drawn: XXX	Profile: Standing Seam		
Scale: NTS	Detail: Hip Detail		
Dwg. Chk. XXX	Dwg. No.		
Date: 01/01/2019	005		
	Job. No.	Sheet No.	Rev.

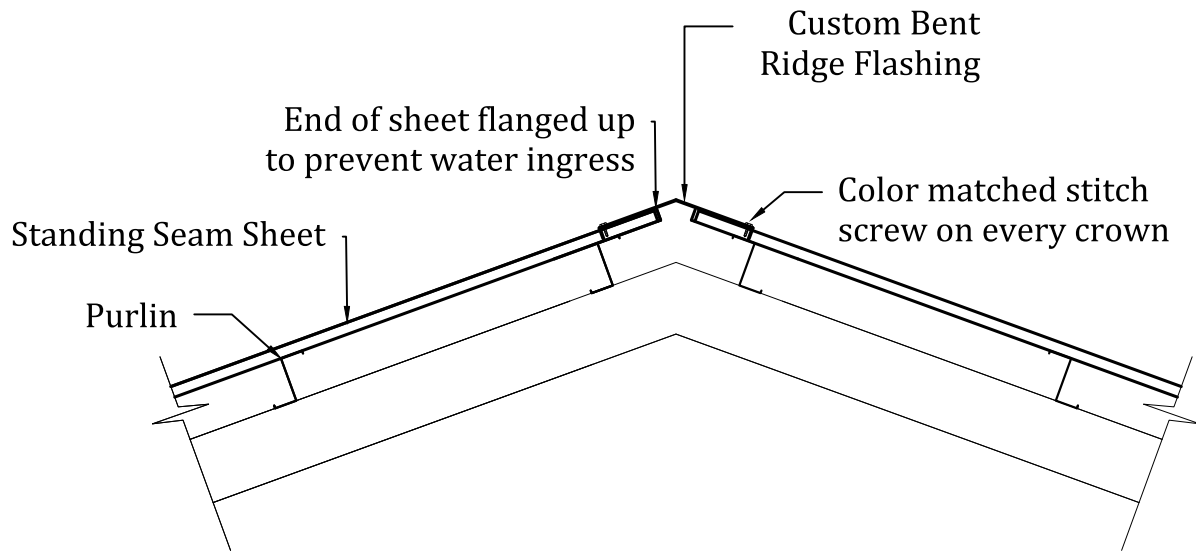

RIDGE - TYPICAL

**ROOF SYSTEMS**  
**RELCO**  
**LIFT UP**  
CARIBBEAN  
**GGI**  
WINDOWS & DOORS

**MORE** than just roofing

TEL: 1(868) 285-9164 [www.roofsystemstt.com](http://www.roofsystemstt.com)

Drawn: XXX	Profile: Standing Seam
Scale: NTS	Detail: Ridge Detail
Dwg. Chk. XXX	Dwg. No.
Date: 01/01/2019	004
	Job. No.   Sheet No.   Rev.

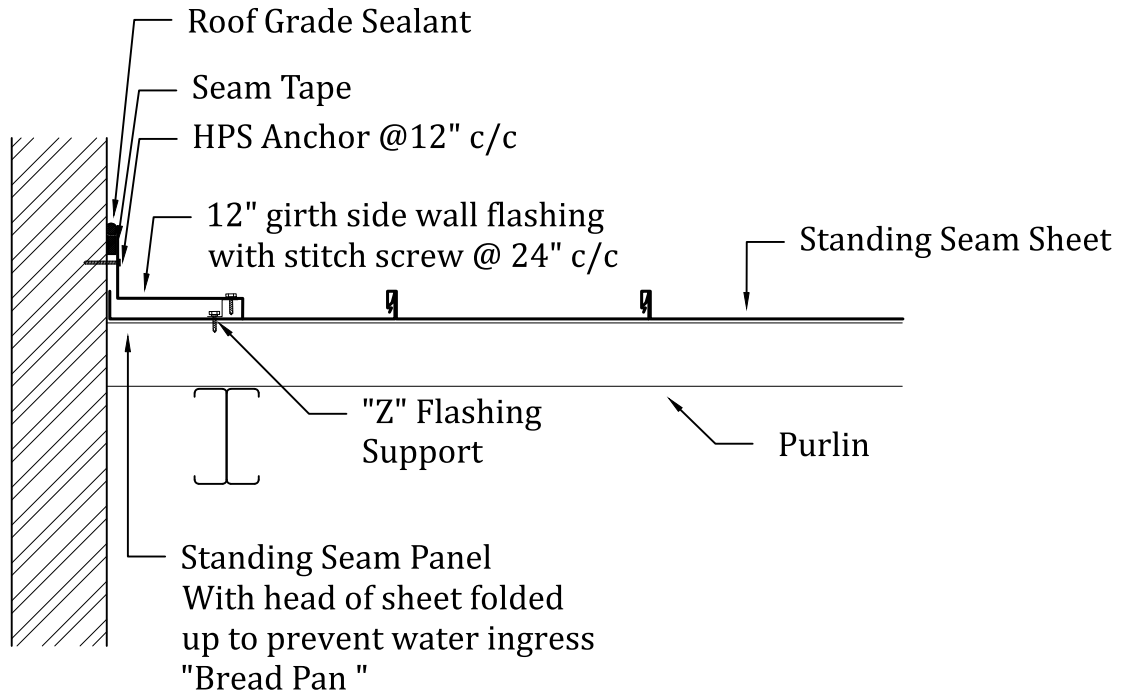

SIDE WALL - TYPICAL





**ROOF SYSTEMS™** **RELLCO** **LIFT IT** **GGI**  
CARIBBEAN WINDOWS & DOORS  
**MORE than just roofing**  
**TEL: 1(868) 285-9164 www.roofsystemstt.com**

Drawn: XXX	Profile: Standing Seam		
Scale: NTS	Detail: Side Wall Detail		
Dwg. Chk. XXX	Dwg. No.		
Date: 01/01/2019	007		
	Job. No.	Sheet No.	Rev.

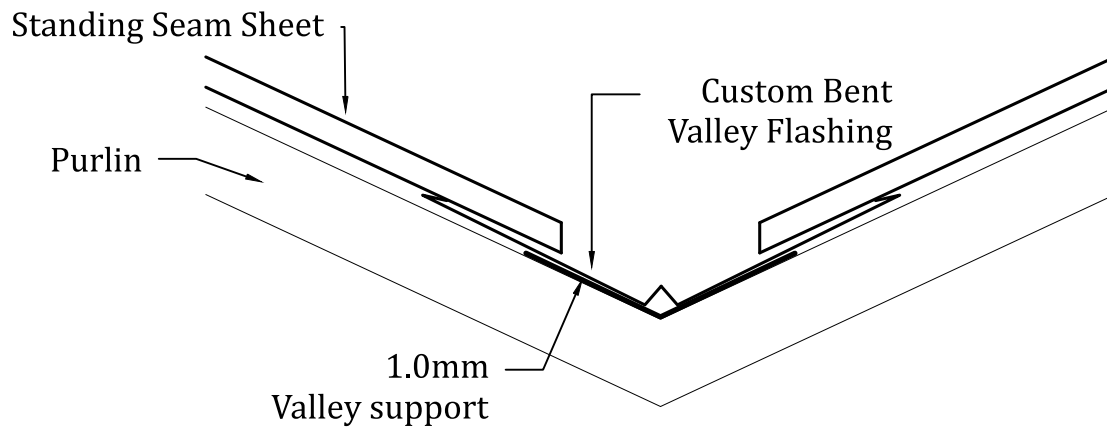

VALLEY - TYPICAL





**MORE than just roofing**

TEL: 1(868) 285-9164 [www.roofsystemstt.com](http://www.roofsystemstt.com)

Drawn: XXX	Profile: Standing Seam
Scale: NTS	Detail: Valley Detail
Dwg. Chk. XXX	Dwg. No.
Date: 01/01/2019	003
	Job. No.   Sheet No.   Rev.